

Specifications

- Current rating:1A AC,DC
- Voltage rating:100V AC,DC
- Temperature range:-40°C~+105°C
- Contact resistance:30mΩMax.
- Insulation resistance:500MΩMin.
- Withstanding voltage:500V AC/minute
- *Compliant with RoHS and REACH*
- *Meet the HF/Halogen Free,need to customize*
- *Contact CJT for details*

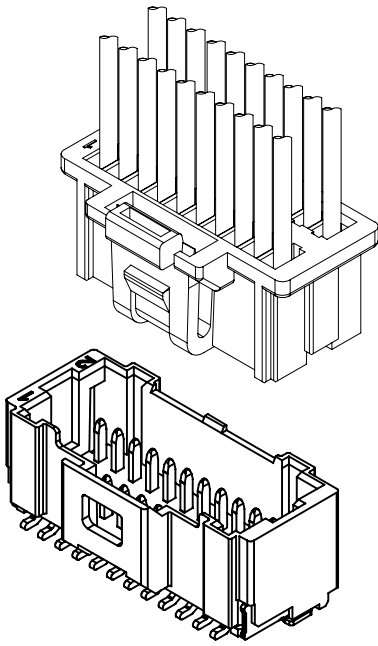

Assembly layout

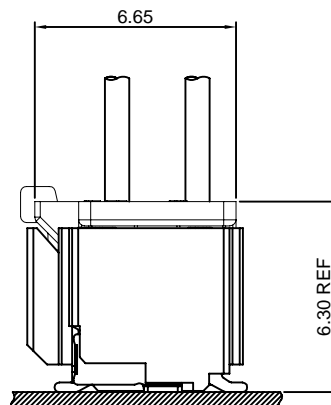

A1008-T

1.00mm pitch Crimp Terminal

Reference Informations:

*Used in CJT A1008H-XP, A1008H-2xXP series Housing

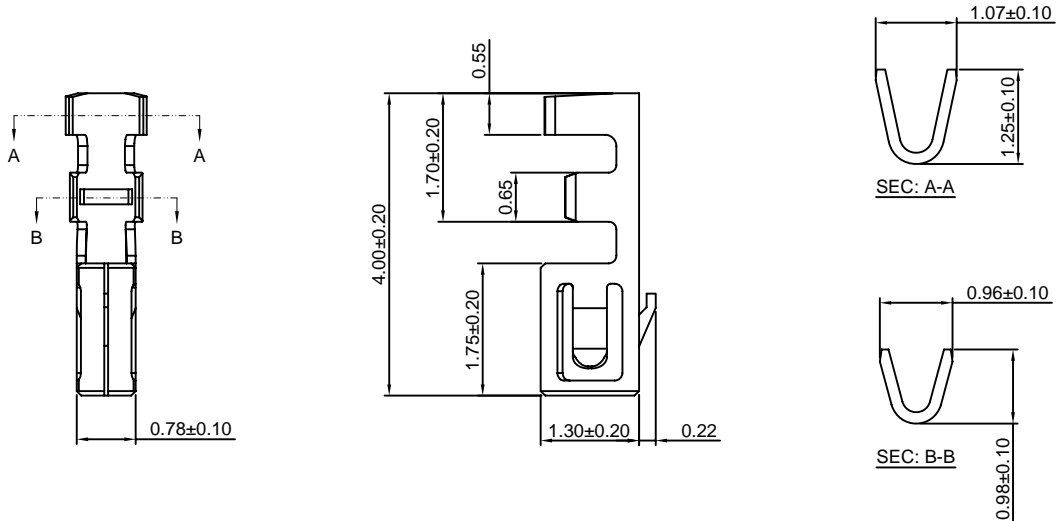

Ordering information & Specifications:

Unit:mm

Part NO.	Wire Range	Insulation O.D.	Material	Finish	Qty/reel
A1008-TP	AWG#28-#32	0.80mm(max)	Phosphor Bronze	Tin over Nickel	15,000 PCS
A1008-GP	AWG#28-#32	0.80mm(max)	Phosphor Bronze	Gold over Nickel	15,000 PCS

Optional Gold plating available but MOQ requested

A1008H-XP

1.00mm pitch Single Row Housing

Reference Informations:

*Material: Nylon 66, UL94V-0

*Suitable CJT A1008-T series Terminal

*Color: White

Ordering Information:

A1008H-XP - ***
1 2

1. Part No.

2. Material:

(Blank): Nylon 66, UL94V-0

GWT: Nylon 66, UL94V-0 GWT 750 °C

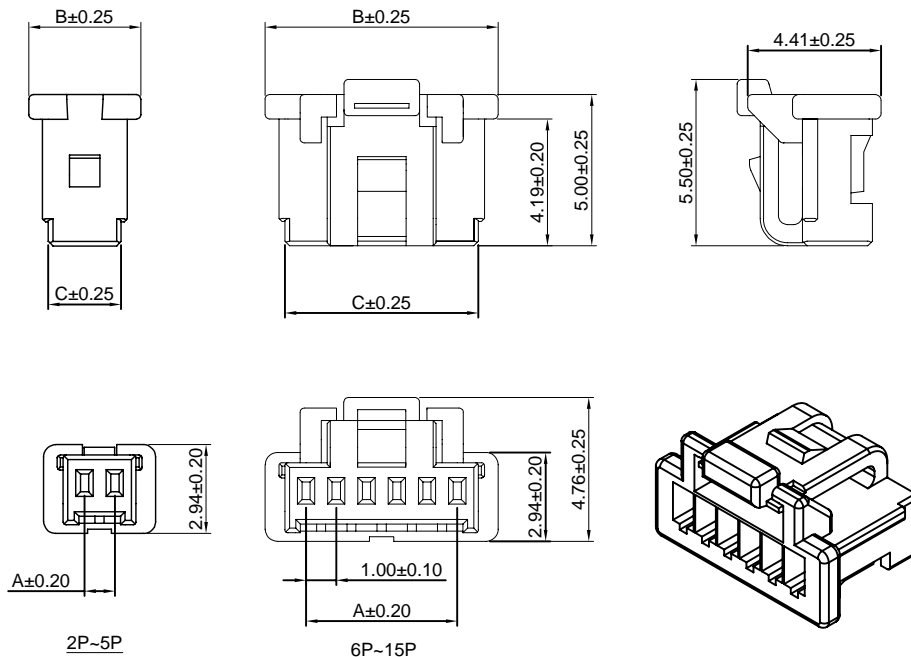

Ordering Information & Dimensions:

PART NO.	Dimensions		
	A	B	C
2P	1.00	3.70	2.40
3P	2.00	4.70	3.40
4P	3.00	5.70	4.40
5P	4.00	6.70	5.40
6P	5.00	7.70	6.40
7P	6.00	8.70	7.40
8P	7.00	9.70	8.40
9P	8.00	10.70	9.40
10P	9.00	11.70	10.40
11P	10.00	12.70	11.40
12P	11.00	13.70	12.40
13P	12.00	14.70	13.40
14P	13.00	15.70	14.40
15P	14.00	16.70	15.40

Unit: mm

A1008H-2xXP

1.00mm pitch Dual Row Housing

Reference Informations:

- *Material: Nylon 66,UL94V-0
- *Suitable CJT A1008-T series Terminal
- *Mates with CJT A1008WV-S-2xXP series Dual Row Wafer
- *Color:White

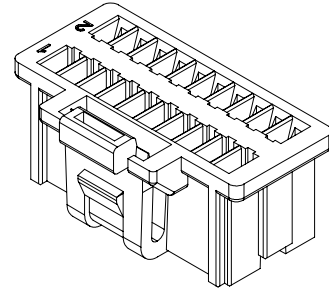
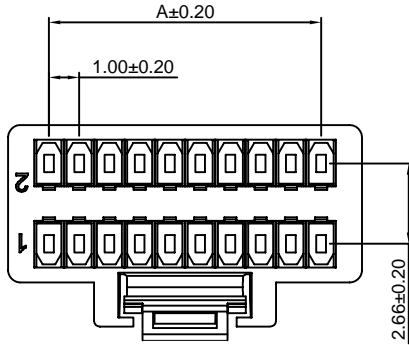

Ordering Information:

A1008H-2xXP - ***
1 2

1.Part No.

2.Material:

(Blank):Nylon 66,UL94V-0

GWT:Nylon 66,UL94V-0 GWT 750 °C

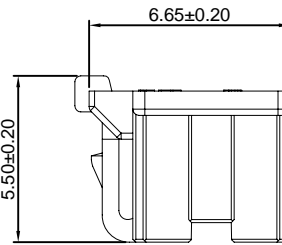
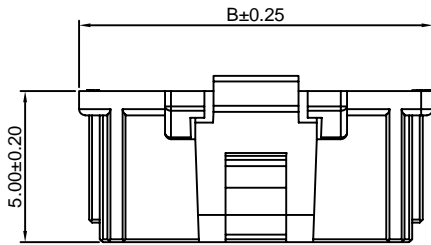

Ordering Information & Dimensions:

PART NO.	Dimensions	
	A	B
2x10P	9.00	11.70
2x15P	14.00	16.70
2x16P	15.00	17.70
2x20P	19.00	21.70
2x25P	24.00	26.70

Unit: mm

A1008WV-S-2xXP

1.00mm pitch 180° Dual Row Wafer-SMT TYPE

Reference Informations:

- *Material:Pin:Phosphor Bronze/Gold over Nickel
Insulator:Nylon 6T,UL94V-0
- *Mates with CJT A1008H-2xXP series Dual Row Housing
- *Color:Beige

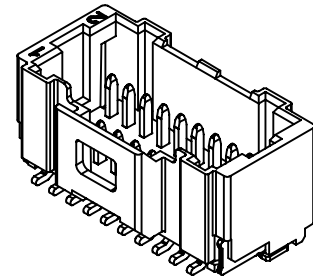
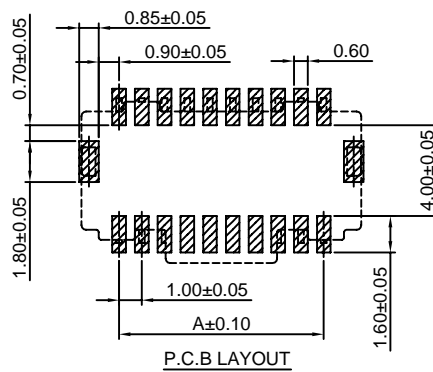
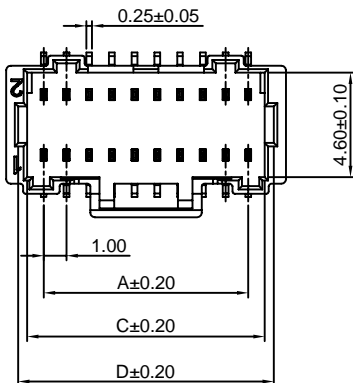

Ordering Information:

A1008WV-S-2xXP - ***
1 2

1.Part No.

2.Material:

(Blank):Nylon 6T,UL94V-0

GWT:Nylon 6T,UL94V-0 GWT 750 °C

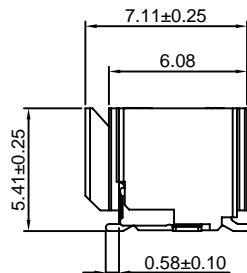
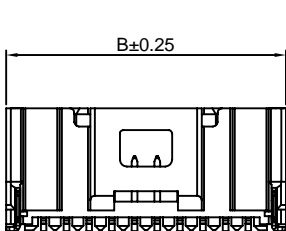

Ordering Information & Dimensions:

PART NO.	Dimensions			
	A	B	C	D
2x10P	9.00	12.30	10.45	11.25
2x15P	14.00	17.30	15.45	16.25
2x20P	19.00	22.30	20.45	21.25
2x25P	24.00	27.30	25.45	26.25

Unit: mm