

Specifications

- Current rating:7A AC,DC
- Voltage rating:250V AC,DC
- Temperature range:-40°C~+105°C
- Contact resistance:10mΩMax.
- Insulation resistance:1000MΩMin.
- Withstanding voltage:1500V AC/minute
- *Compliant with RoHS and REACH*
- *Meet the HF/Halogen Free,GWT/Glow wire Test (IEC60335-1) request,need to customize*
- *Contact CJT for details*

Standards



Assembly layout

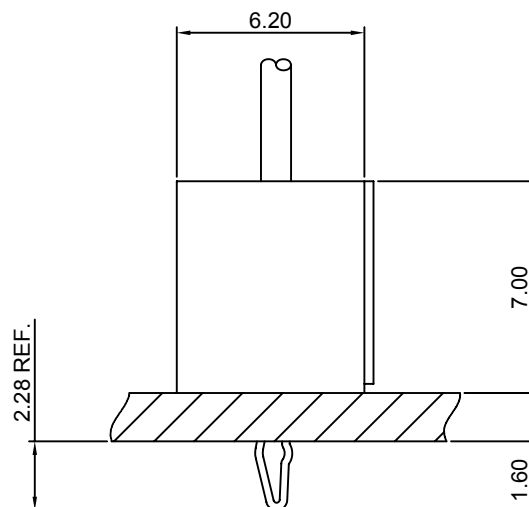

B3952-T

3.96mm pitch Crimp Terminal

Reference Informations:

*Used in CJT B3952 series Housing

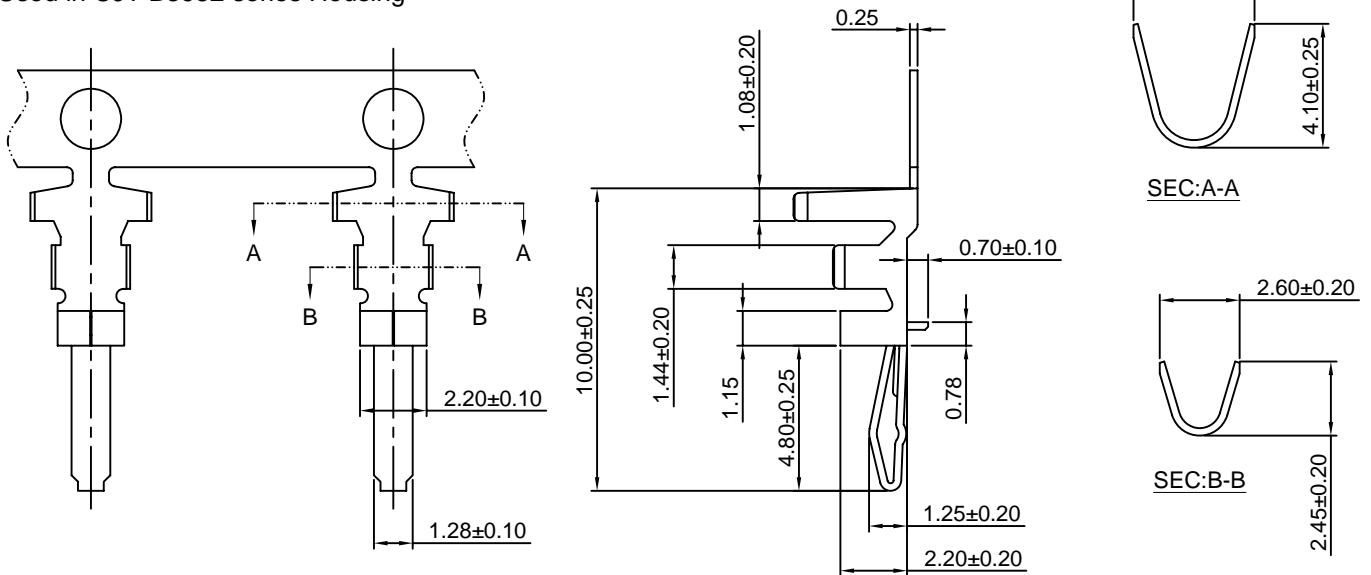

Ordering information & Specifications:

Unit:mm

Part NO.	Wire Range	Insulation O.D.	Material	Finish	Qty/reel
B3952-TB	AWG#18-#22	3.00mm(max)	Brass	Tin over Nickel	5,000 PCS
B3952-TP	AWG#18-#22	3.00mm(max)	Phosphor Bronze	Tin over Nickel	5,000 PCS
B3952-GB	AWG#18-#22	3.00mm(max)	Brass	Gold over Nickel	5,000 PCS
B3952-GP	AWG#18-#22	3.00mm(max)	Phosphor Bronze	Gold over Nickel	5,000 PCS

Optional Gold plating available but MOQ requested

B3952H

3.96mm pitch Housing

Reference Informations:

*Material:Nylon 66,UL94V-0

*Suitable CJT B3952 series Terminal

*Color:Natural(white)

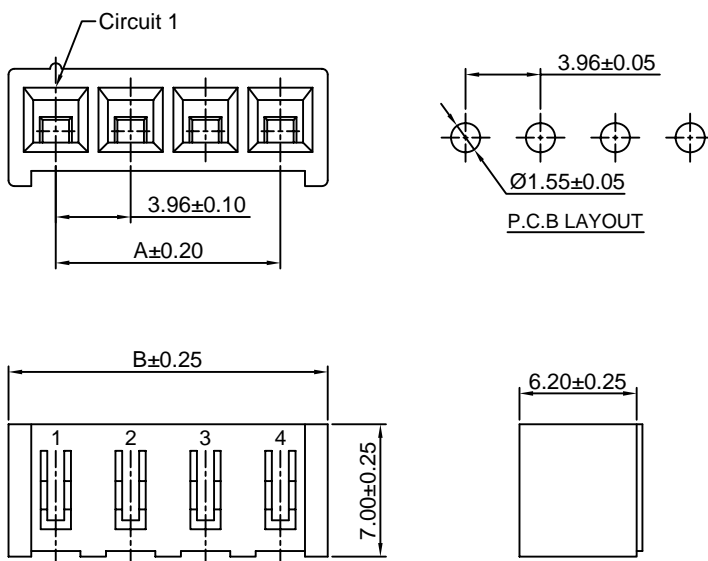
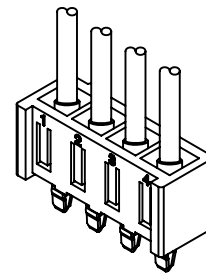

Ordering Information & Dimensions:

PART NO.	Dimensions	
	A	B
B3952H-2P	3.96	8.96
B3952H-3P	7.92	12.92
B3952H-4P	11.88	16.88
B3952H-5P	15.85	20.84
B3952H-6P	19.80	24.80
B3952H-7P	23.76	28.76
B3952H-8P	27.72	32.72
B3952H-9P	31.68	36.68
B3952H-10P	35.64	40.64
B3952H-11P	39.60	44.60
B3952H-12P	43.56	48.56
B3952H-13P	47.52	52.52
B3952H-14P	51.48	56.48
B3952H-15P	55.44	60.44

Unit: mm

B3952H-F

3.96mm pitch Housing

Reference Informations:

- *Material:Nylon 66,UL94V-0
- *Suitable CJT B3952 series Terminal
- *Color:Natural(white)

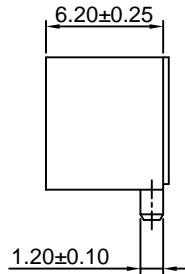
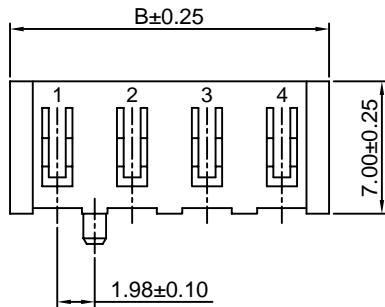
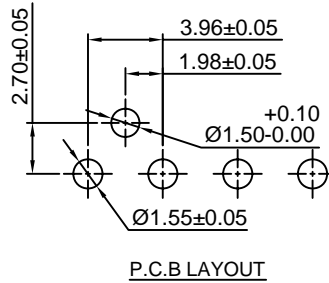
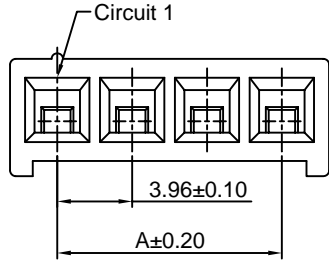
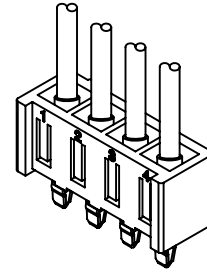

Ordering Information & Dimensions:

PART NO.	Dimensions	
	A	B
B3952H-F-2P	3.96	8.96
B3952H-F-3P	7.92	12.92
B3952H-F-4P	11.88	16.88
B3952H-F-5P	15.85	20.84
B3952H-F-6P	19.80	24.80
B3952H-F-7P	23.76	28.76
B3952H-F-8P	27.72	32.72
B3952H-F-9P	31.68	36.68
B3952H-F-10P	35.64	40.64
B3952H-F-11P	39.60	44.60
B3952H-F-12P	43.56	48.56
B3952H-F-13P	47.52	52.52
B3952H-F-14P	51.48	56.48
B3952H-F-15P	55.44	60.44

Unit: mm