

## Specifications

- Current rating:7A AC,DC
- Voltage rating:250V AC,DC
- Temperature range:-40°C~+105°C
- Contact resistance:10mΩMax.
- Insulation resistance:1000MΩMin.
- Withstanding voltage:1000V AC/minute
- \*Compliant with RoHS and REACH\*
- \*Meet the HF/Halogen Free,GWT/Glow wire Test (IEC60335-1) request,need to customize\*
- \*Contact CJT for details\*

## Standards



## Assembly layout

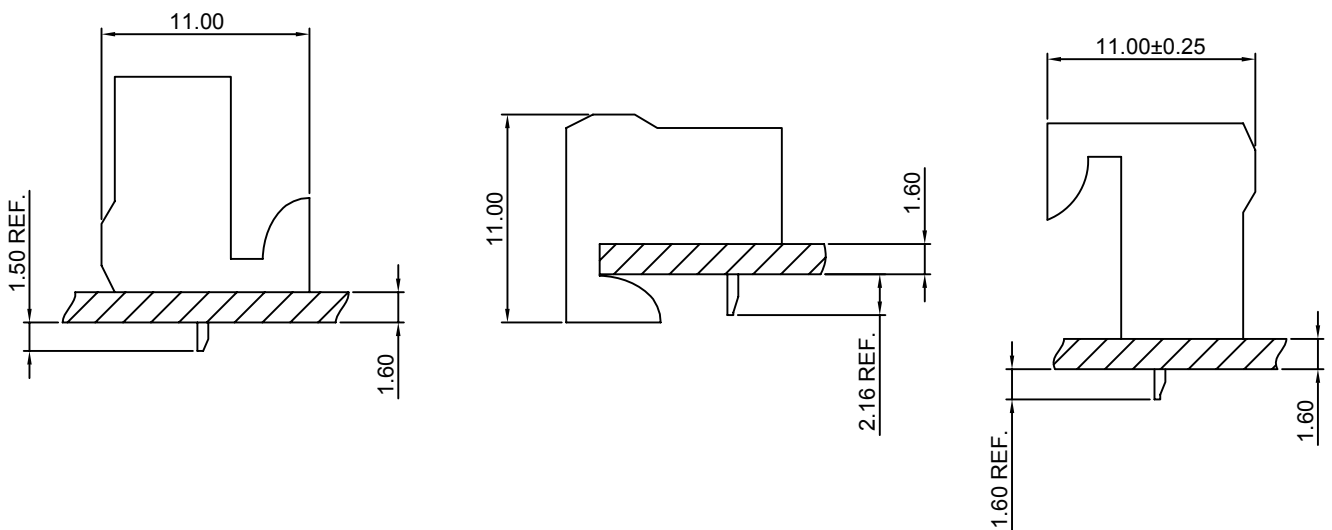

### B3961AW

3.96mm Pitch Bottom Entry Housing

**Reference Informations:**

- \*Material:Nylon 66,UL94V-2
- \*Mates with CJT A3961 series Wafer
- \*Color:Natural(Transparent)

Ordering Information:  
B3961AW-XP - \*  
 1                    2

1.Part No.  
 2.Material:  
 (blank)-UL94V-2/Natural  
V0-UL94V-0/White

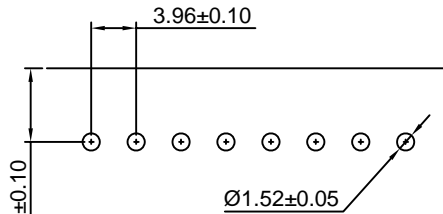
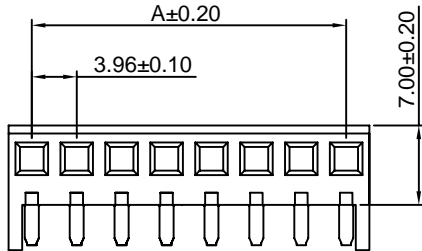
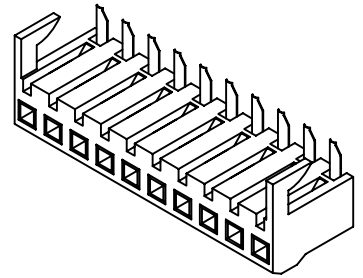

P.C.B LAYOUT

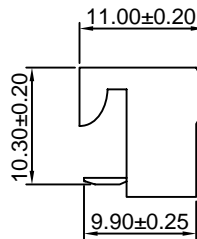
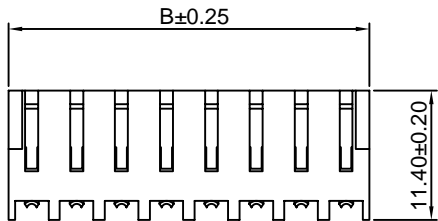

Ordering Information & Dimensions:

PART NO.	Dimensions	
	A	B
B3961AW-2P	3.96	8.06
B3961AW-3P	7.92	12.02
B3961AW-4P	11.88	15.98
B3961AW-5P	15.84	19.94
B3961AW-6P	19.80	23.90
B3961AW-7P	23.76	27.86
B3961AW-8P	27.72	31.82
B3961AW-9P	31.68	35.78
B3961AW-10P	35.64	39.74
B3961AW-11P	39.60	43.70
B3961AW-12P	43.56	47.66
B3961AW-13P	47.52	51.62
B3961AW-14P	51.48	55.58
B3961AW-15P	55.44	59.54
B3961AW-16P	59.40	63.50

Unit: mm

### B3961BW

3.96mm Pitch Bottom Entry Housing

**Reference Informations:**

- \*Material:Nylon 66,UL94V-2
- \*Mates with CJT A3961 series Wafer
- \*Color:Natural(Transparent)

Ordering Information:  
B3961BW-XP - \*  
 1                    2

1.Part No.  
 2.Material:  
 (blank)-UL94V-2/Natural  
V0-UL94V-0/White

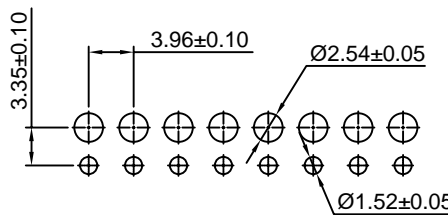
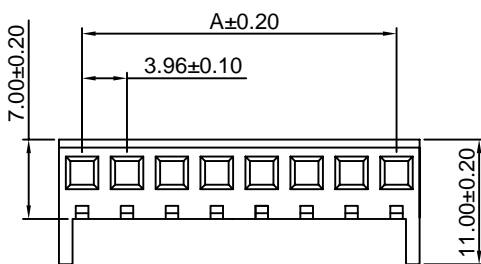
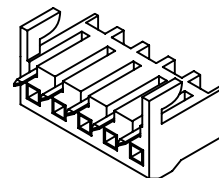

P.C.B LAYOUT

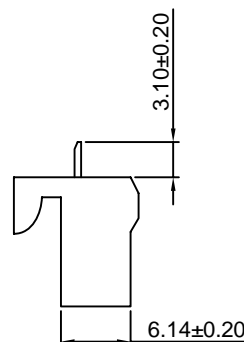
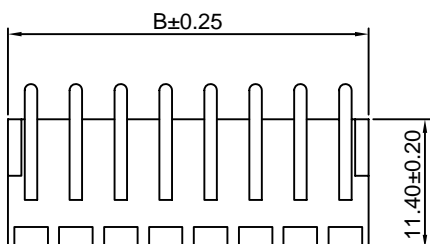

Ordering Information & Dimensions:

PART NO.	Dimensions	
	A	B
B3961BW-2P	3.96	8.06
B3961BW-3P	7.92	12.02
B3961BW-4P	11.88	15.98
B3961BW-5P	15.84	19.94
B3961BW-6P	19.80	23.90
B3961BW-7P	23.76	27.86
B3961BW-8P	27.72	31.82
B3961BW-9P	31.68	35.78
B3961BW-10P	35.64	39.74
B3961BW-11P	39.60	43.70
B3961BW-12P	43.56	47.66
B3961BW-13P	47.52	51.62
B3961BW-14P	51.48	55.58
B3961BW-15P	55.44	59.54
B3961BW-16P	59.40	63.50

Unit: mm

### B3961CW

3.96mm Pitch Bottom Entry Housing

#### Reference Informations:

- \*Material: Nylon 66, UL94V-2
- \*Mates with CJT A3961 series Wafer
- \*Color: Natural(Transparent)

#### Ordering Information:

- B3961CW-XP - \*  
 1                    2  
 1. Part No.  
 2. Material:  
 (blank)-UL94V-2/Natural  
 V0-UL94V-0/White

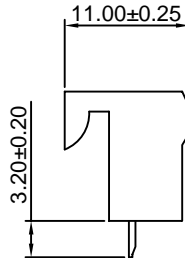
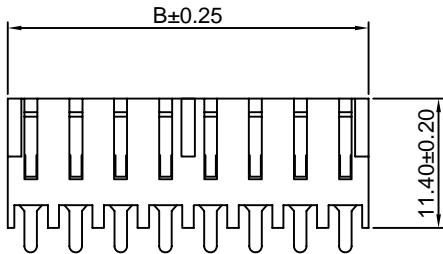
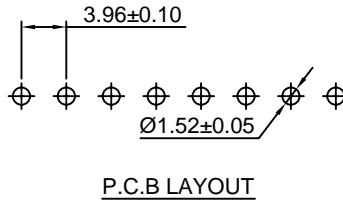
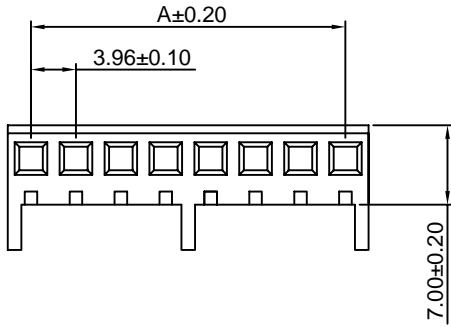
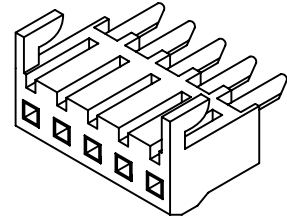

#### Ordering Information & Dimensions:

PART NO.	Dimensions	
	A	B
B3961CW-2P	3.96	8.06
B3961CW-3P	7.92	12.02
B3961CW-4P	11.88	15.98
B3961CW-5P	15.84	19.94
B3961CW-6P	19.80	23.90
B3961CW-7P	23.76	27.86
B3961CW-8P	27.72	31.82
B3961CW-9P	31.68	35.78
B3961CW-10P	35.64	39.74
B3961CW-11P	39.60	43.70
B3961CW-12P	43.56	47.66
B3961CW-13P	47.52	51.62
B3961CW-14P	51.48	55.58
B3961CW-15P	55.44	59.54
B3961CW-16P	59.40	63.50

Unit: mm