

## Specifications

Current rating:2A AC,DC  
Voltage rating:125V AC,DC  
Temperature range:-40°C~+105°C  
Contact resistance:20mΩ Max.  
Insulation resistance:1000MΩ Min.  
Withstanding voltage:500V AC/minute  
\*Compliant with RoHS and REACH\*  
\*Meet the HF/Halogen Free,need to customize\*  
\*Contact CJT for details\*

Standards



## Assembly layout

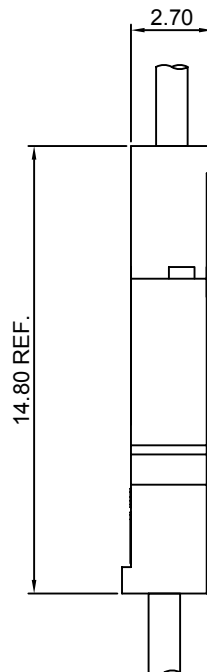

## C2003F-T

2.00mm pitch Crimp Terminal

### Reference Informations:

\*Used in CJT C2003HF series Housing

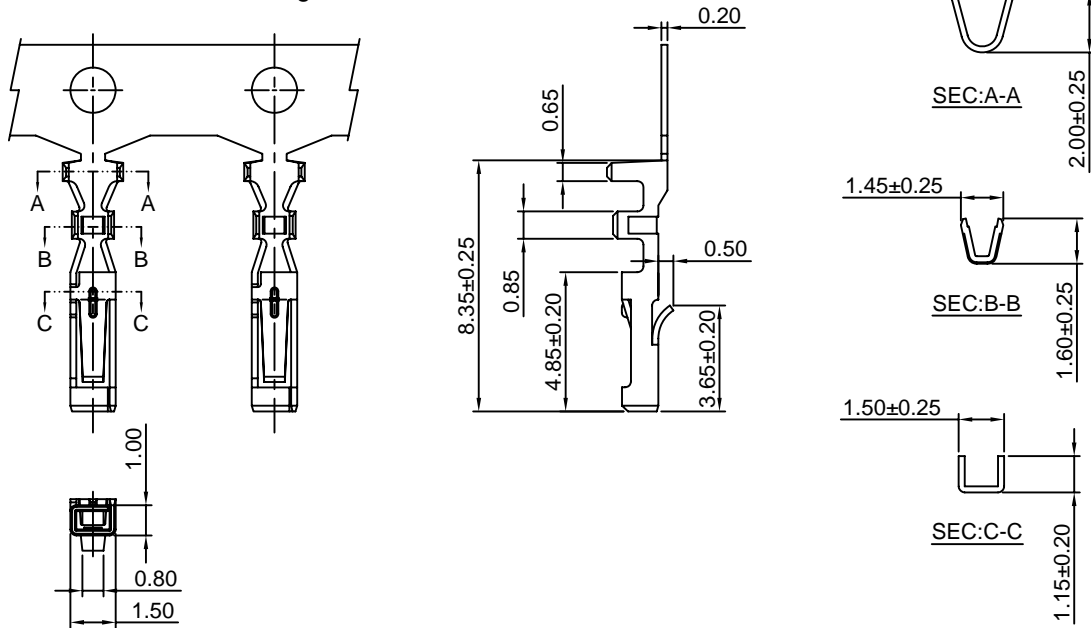

### Ordering information & Specifications:

Unit:mm

Part NO.	Wire Range	Insulation O.D.	Material	Finish	Qty/reel
C2003F-TP	AWG#24-#28	1.15mm(max)	Phosphor Bronze	Tin over Nickel	10,000 PCS
C2003F-GP	AWG#24-#28	1.15mm(max)	Phosphor Bronze	Gold over Nickel	10,000 PCS

Optional Gold plating available but MOQ requested

## C2003M-T

2.00mm pitch Crimp Terminal

### Reference Informations:

\*Used in CJT C2003HM series Housing

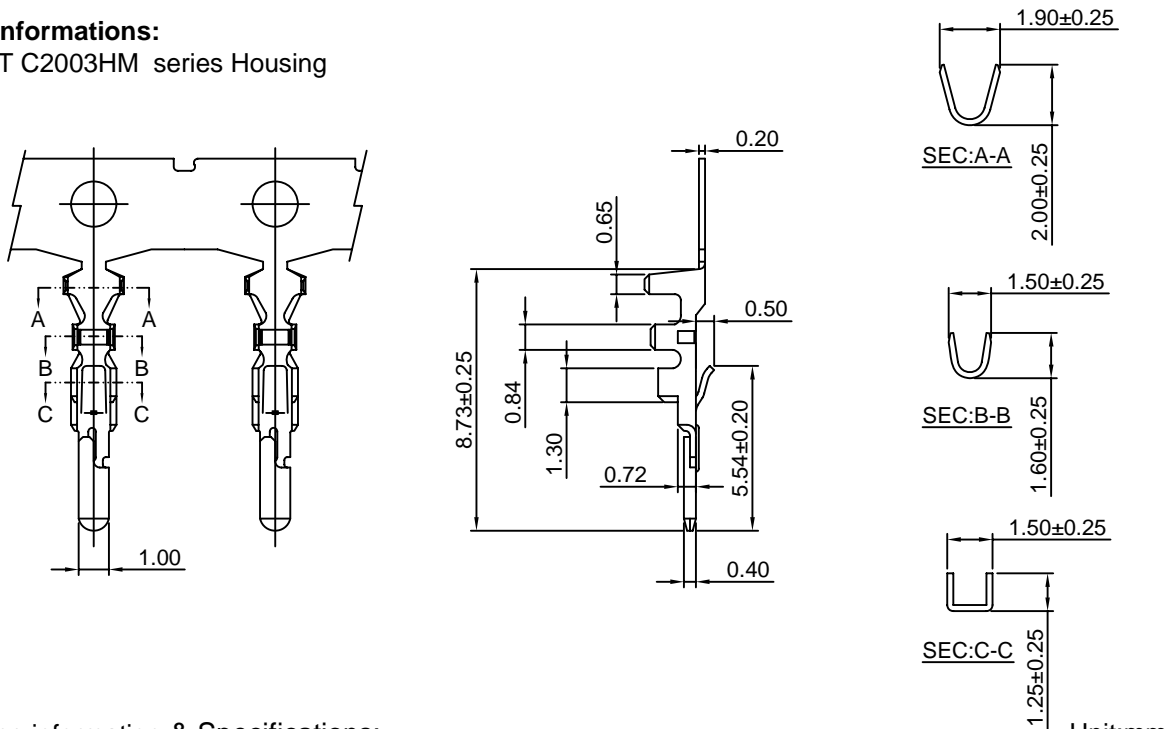

### Ordering information & Specifications:

Unit:mm

Part NO.	Wire Range	Insulation O.D.	Material	Finish	Qty/reel
C2003M-TP	AWG#24-#28	1.15mm(max)	Phosphor Bronze	Tin over Nickel	10,000 PCS
C2003M-GP	AWG#24-#28	1.15mm(max)	Phosphor Bronze	Gold over Nickel	10,000 PCS

Optional Gold plating available but MOQ requested

## C2003HF

2.00mm Pitch Housing

### Reference Informations:

- \*Material:Nylon 66,UL94V-0
- \*Suitable CJT C2003F series Terminal
- \*Mates with CJT C2003HM series Housing
- \*Color:White

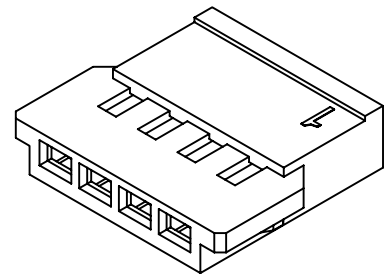
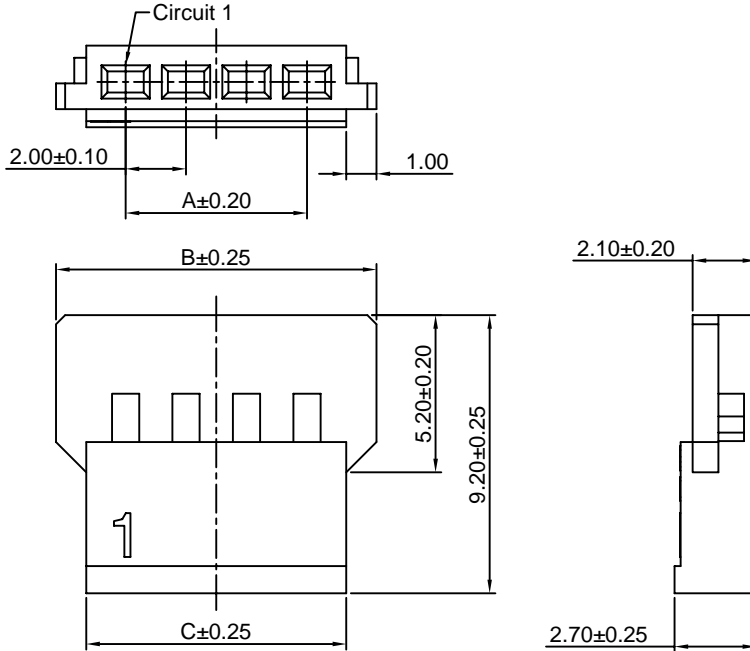

### Ordering Information & Dimensions:

PART NO.	Dimensions		
	A	B	C
C2003HF-2P	2.00	6.60	4.60
C2003HF-3P	4.00	8.60	6.60
C2003HF-4P	6.00	10.60	8.60
C2003HF-5P	8.00	12.60	10.60
C2003HF-6P	10.00	14.60	12.60
C2003HF-7P	12.00	16.60	14.60
C2003HF-8P	14.00	18.60	16.60
C2003HF-9P	16.00	20.60	18.60
C2003HF-10P	18.00	22.60	20.60
C2003HF-11P	20.00	24.60	22.60
C2003HF-12P	22.00	22.60	22.60
C2003HF-13P	24.00	28.60	26.60

Unit: mm

## C2003HM

2.00mm Pitch Housing

### Reference Informations:

- \*Material:Nylon 66,UL94V-0
- \*Suitable CJT C2003M series Terminal
- \*Mates with CJT C2003HF series Housing
- \*Color:White

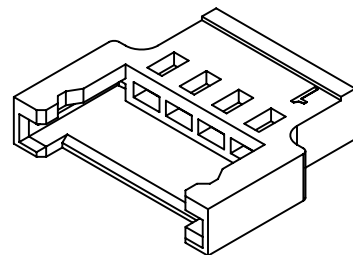
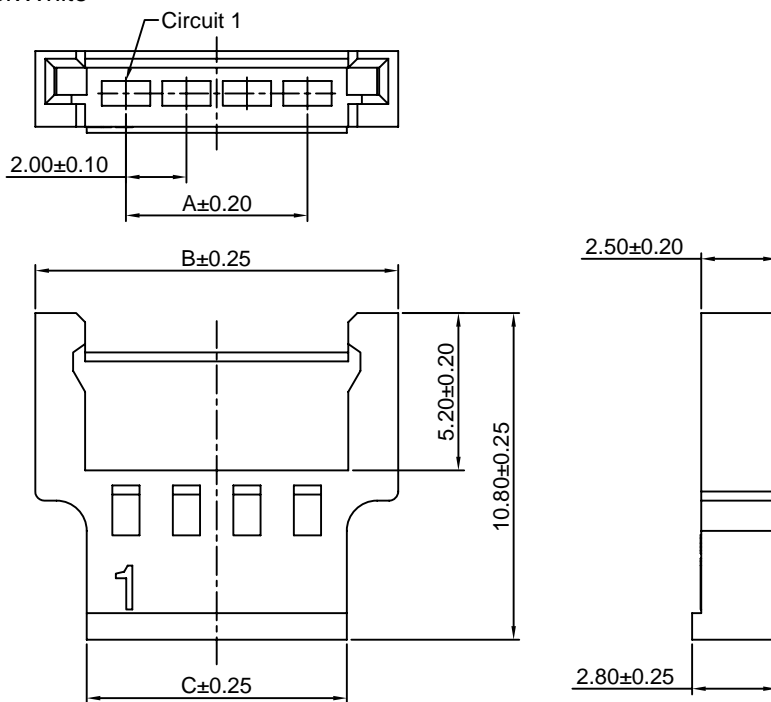

### Ordering Information & Dimensions:

PART NO.	Dimensions		
	A	B	C
C2003HM-2P	2.00	8.00	4.60
C2003HM-3P	4.00	10.00	6.60
C2003HM-4P	6.00	12.00	8.60
C2003HM-5P	8.00	14.00	10.60
C2003HM-6P	10.00	16.00	12.60
C2003HM-7P	12.00	18.00	14.60
C2003HM-8P	14.00	20.00	16.60
C2003HM-9P	16.00	22.00	18.60
C2003HM-10P	18.00	24.00	20.60
C2003HM-11P	20.00	26.00	22.60
C2003HM-12P	22.00	28.00	24.60
C2003HM-13P	24.00	30.00	26.60

Unit: mm