

Specifications

- Current rating:7A AC,DC
Voltage rating:300V AC,DC
Temperature range:-40°C~+105°C
Contact resistance:7mΩ Max.
Insulation resistance:1000MΩ Min.
Withstanding voltage:1500V AC/minute
Compliant with RoHS and REACH
Meet the HF/Halogen Free,GWT/Glow wire Test (IEC60335-1) request,need to customize
Contact CJT for details

Standards



Assembly layout

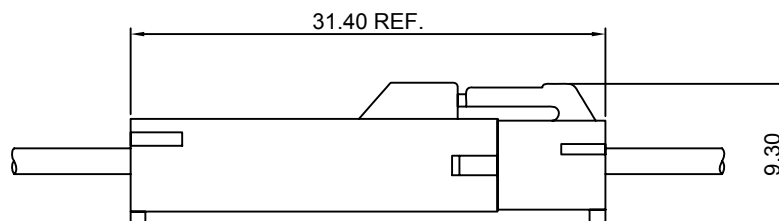

C3961F-T

3.96mm pitch Crimp Terminal

Reference Informations:

*Used in CJT C3961HF series Housing

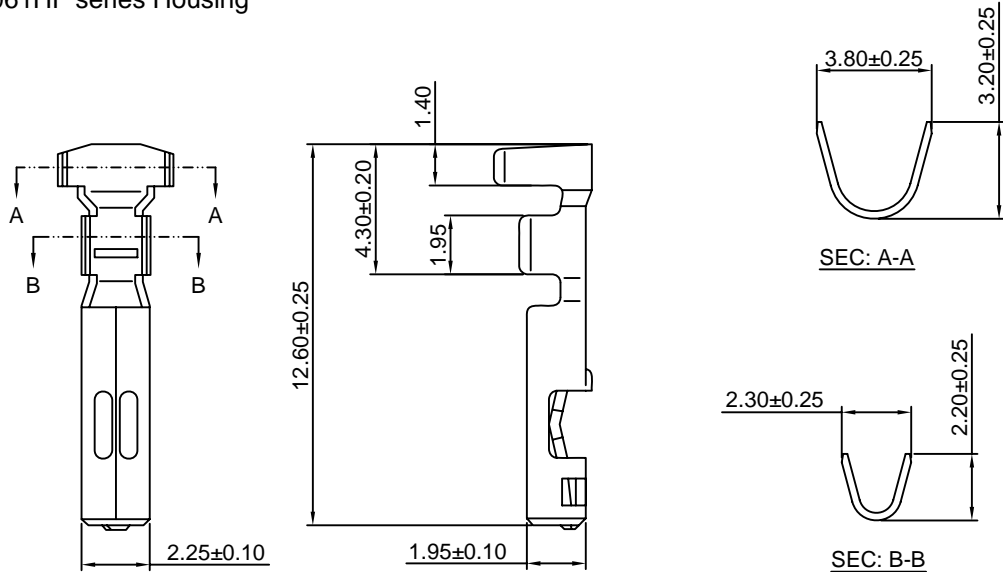

Ordering information & Specifications:

Unit:mm

Part NO	Wire Range	Insulation O.D.	Material	Finish	Qty/reel
C3961F-TP	AWG#20-#26	2.50mm(max)	Phosphor Bronze	Tin over Nickel	15,000 PCS
C3961F-GP	AWG#20-#26	2.50mm(max)	Phosphor Bronze	Gold over Nickel	15,000 PCS

Optional Gold plating available but MOQ requested

C3961M-T

3.96mm pitch Crimp Terminal

Reference Informations:

*Used in CJT C3961HM series Housing

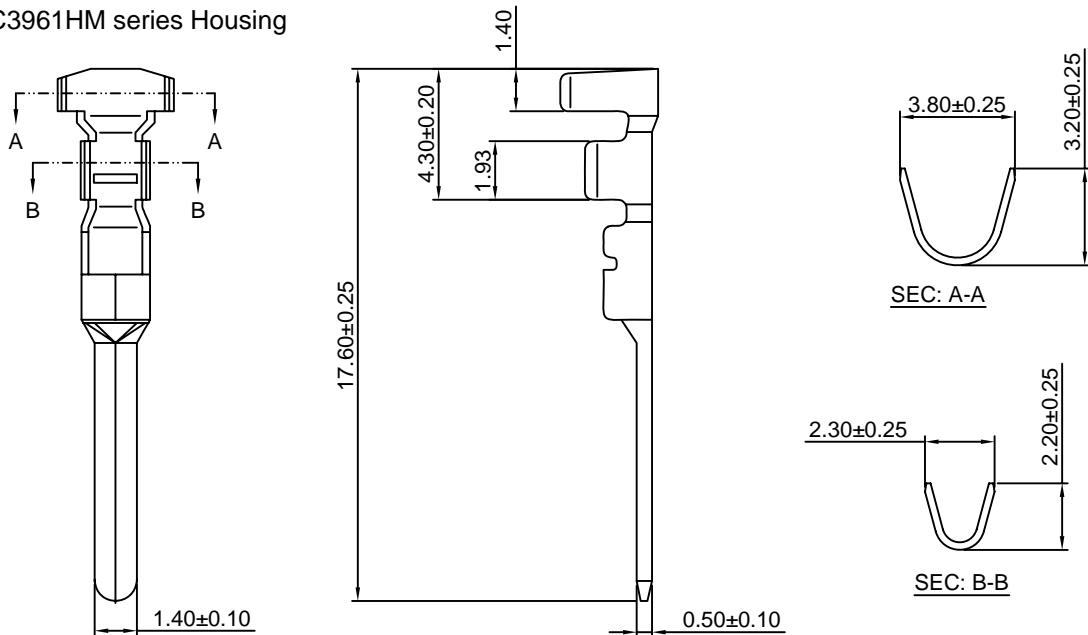

Ordering information & Specifications:

Unit:mm

Part NO	Wire Range	Insulation O.D.	Material	Finish	Qty/reel
C3961M-TP	AWG#20-#26	2.50mm(max)	Phosphor Bronze	Tin over Nickel	15,000 PCS
C3961M-GP	AWG#20-#26	2.50mm(max)	Phosphor Bronze	Gold over Nickel	15,000 PCS

Optional Gold plating available but MOQ requested

C3961HF

3.96mm Pitch Housing

Reference Informations:

- *Material:Nylon 66,UL94V-0
- *Suitable CJT C3961F series Terminal
- *Mates with CJT C3961HM series
- *Color:White

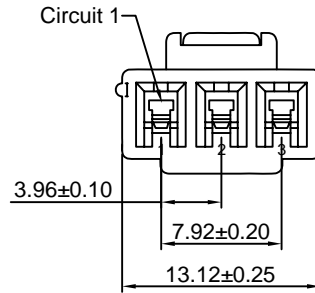
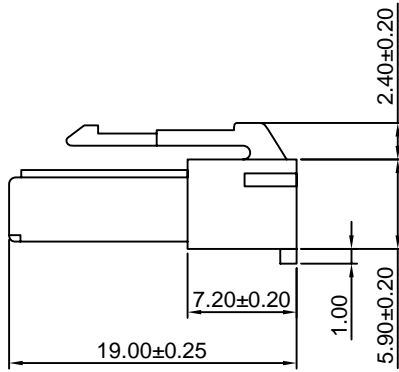

Ordering Information & Dimensions:

PART NO.	Dimensions	
	A	B
C3961HF-1P	-----	5.20
C3961HF-2P	3.96	9.16
C3961HF-3P	7.92	13.12
C3961HF-4P	11.88	17.08
C3961HF-5P	15.84	21.04

Unit: mm

C3961HM

3.96mm Pitch Housing

Reference Informations:

- *Material:Nylon 66,UL94V-0
- *Suitable CJT C3961M series Terminal
- *Mates with CJT C3961HF series Housing
- *Color: White

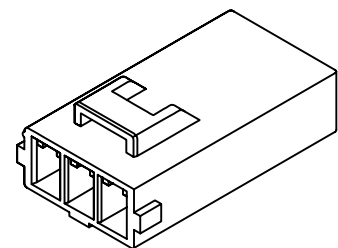
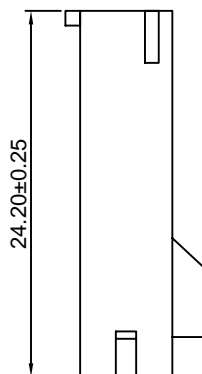
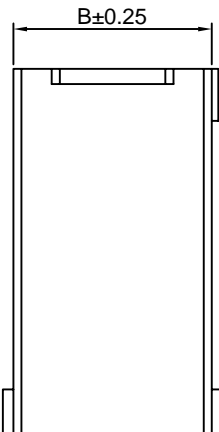
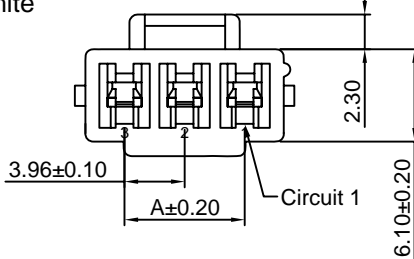

Ordering Information & Dimensions:

PART NO.	Dimensions	
	A	B
C3961HM-1P	-----	5.20
C3961HM-2P	3.96	9.16
C3961HM-3P	7.92	13.12
C3961HM-4P	11.88	17.08
C3961HM-5P	15.84	21.04

Unit: mm

C3961HF-2x3P

3.96mm Pitch Dual Row Housing

Reference Informations:

- *Material:Nylon 66,UL94V-0
- *Suitable CJT C3961F series Terminal
- *Mates with CJT C3961HM Dual Row series Housing
- *Color:White

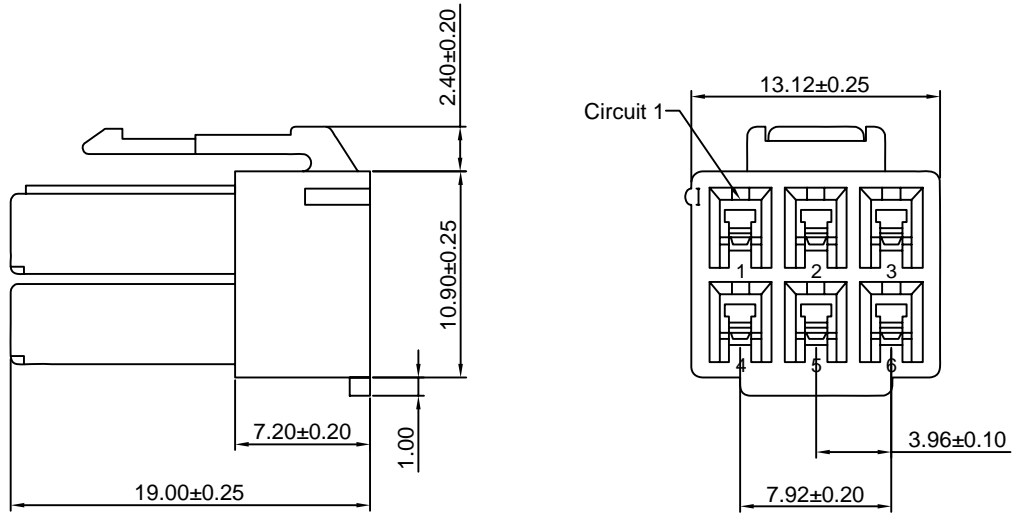

Unit: mm

C3961HM-2x3P

3.96mm Pitch Dual Row Housing

Reference Informations:

- *Material:Nylon 66,UL94V-0
- *Suitable CJT C3961M series Terminal
- *Mates with CJT C3961HF series Dual Row Housing
- *Color:White

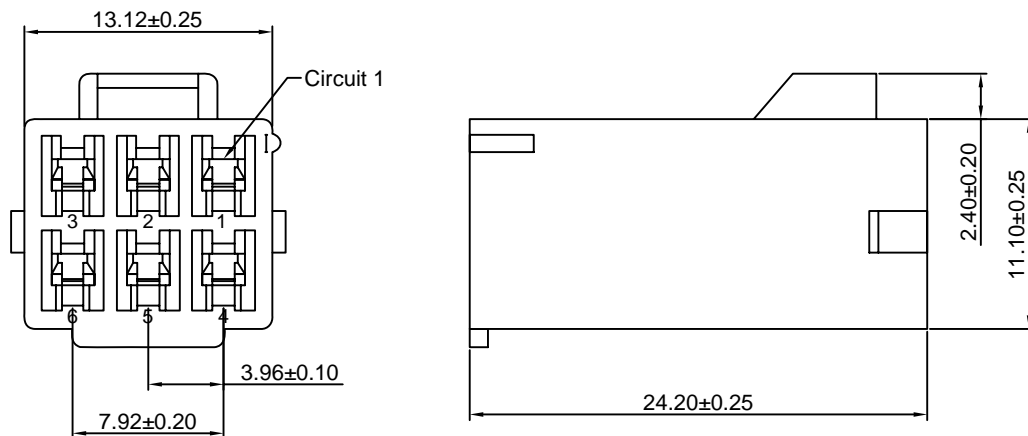
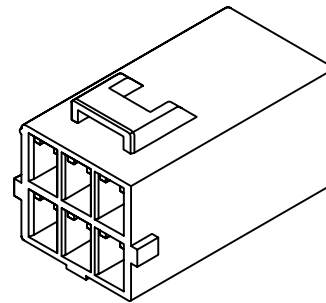

Unit: mm