

## Specifications

- Current rating:10A AC,DC
- Voltage rating:300V AC,DC
- Temperature range:-40°C~+105°C
- Contact resistance:7mΩ Max.
- Insulation resistance:1000MΩ Min.
- Withstanding voltage:1500V AC/minute
- \*Compliant with RoHS and REACH\*
- \*Meet the HF/Halogen Free,GWT/Glow wire Test (IEC60335-1) request,need to customize\*
- \*Contact CJT for details\*

## Standards



## Assembly layout

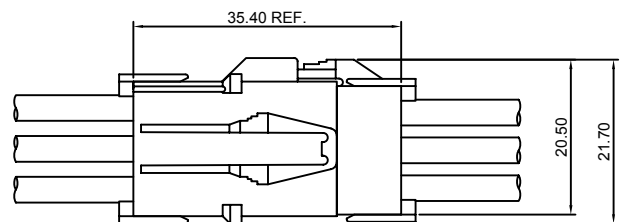
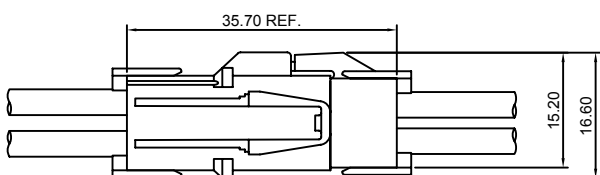
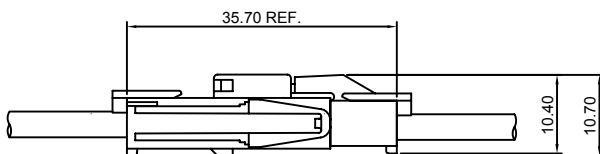
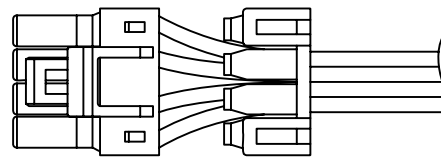
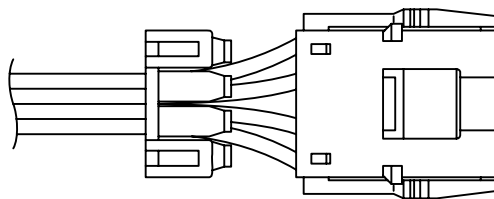

## Panel hole layout

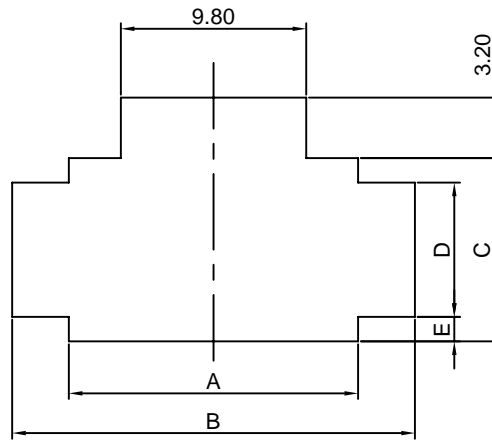

Unit:mm

PART NO.	Panel thickness and Dimensions (mm)								
	0.70 to 2.00			0.70 to 0.80		0.90 to 1.30		1.40 to 2.00	
	A	B	C	D	E	D	E	D	E
C4501HM-2P	10.70	16.80	7.10	4.40	1.35	5.00	1.05	5.60	0.75
C4501HM-3P	15.30	21.30	7.10	4.40	1.35	5.00	1.05	5.60	0.75
C4501HM-2x2P	10.70	16.80	12.90	7.10	2.90	7.70	2.60	8.30	2.30
C4501HM-2x3P	15.30	21.30	12.90	7.10	2.90	7.70	2.60	8.30	2.30
C4501HM-2x4P	19.80	25.80	12.90	7.10	2.90	7.70	2.60	8.30	2.30
C4501HM-2x6P	28.90	34.80	12.90	7.10	2.90	7.70	2.60	8.30	2.30
C4501HM-2x8P	37.90	43.80	12.90	7.10	2.90	7.70	2.60	8.30	2.30
C4501HM-3x3P	15.30	21.30	18.20	7.10	5.55	7.70	5.25	8.30	4.95
C4501HM-3x4P	19.80	25.80	18.20	7.10	5.55	7.70	5.25	8.30	4.95
C4501HM-3x5P	24.40	30.30	18.20	7.10	5.55	7.70	5.25	8.30	4.95

- Note: 1. Punch holes in the panel according to the figures and table shown above. Burrs must be removed.  
 2. The strength of the panel must be considered when punching two or more holes.  
 3. The connector must be inserted from the same side as the hole is punched.

## C4501F-T

4.50mm pitch Crimp Terminal

### Reference Informations:

\*Used in CJT C4501HF series Housing

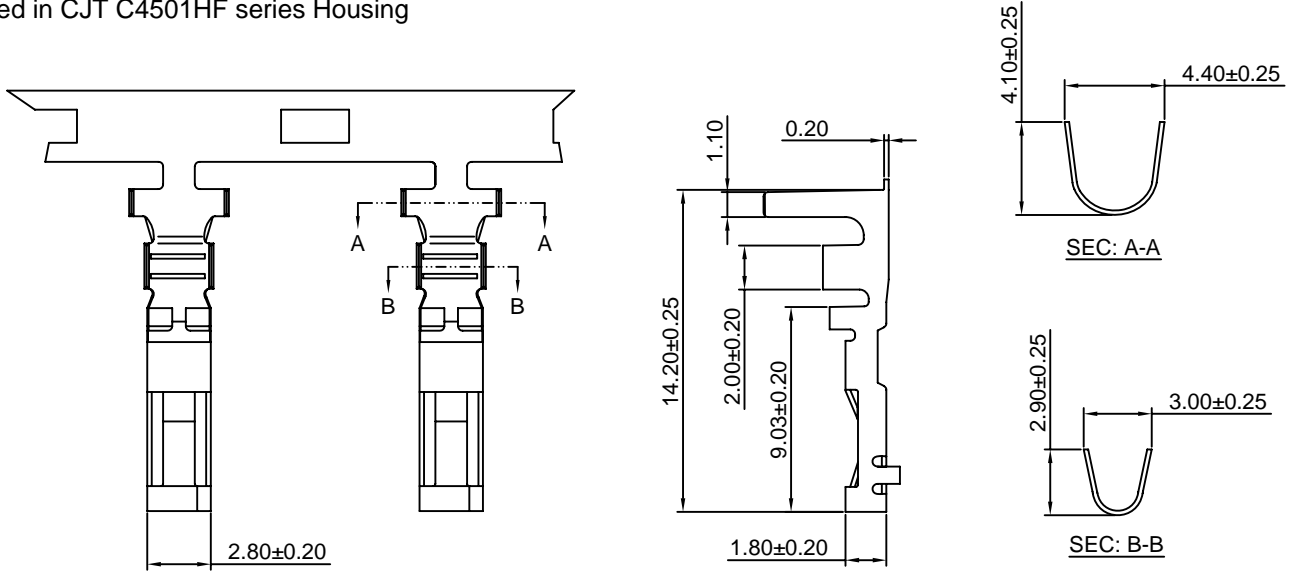

### Ordering information & Specifications:

Unit:mm

Part NO.	Wire Range	Insulation O.D.	Material	Finish	Qty/reel
C4501F-TP	AWG#16-#20	3.40mm(max)	Phosphor Bronze	Tin over Nickel	4,000 PCS
C4501F-GP	AWG#16-#20	3.40mm(max)	Phosphor Bronze	Gold over Nickel	4,000 PCS
C4501F-TP-L	AWG#20-#26	2.50mm(max)	Phosphor Bronze	Tin over Nickel	4,000 PCS
C4501F-GP-L	AWG#20-#26	2.50mm(max)	Phosphor Bronze	Gold over Nickel	4,000 PCS

Optional Gold plating available but MOQ requested

## C4501M-T

4.50mm pitch Crimp Terminal

### Reference Informations:

\*Used in CJT C4501HM series Housing

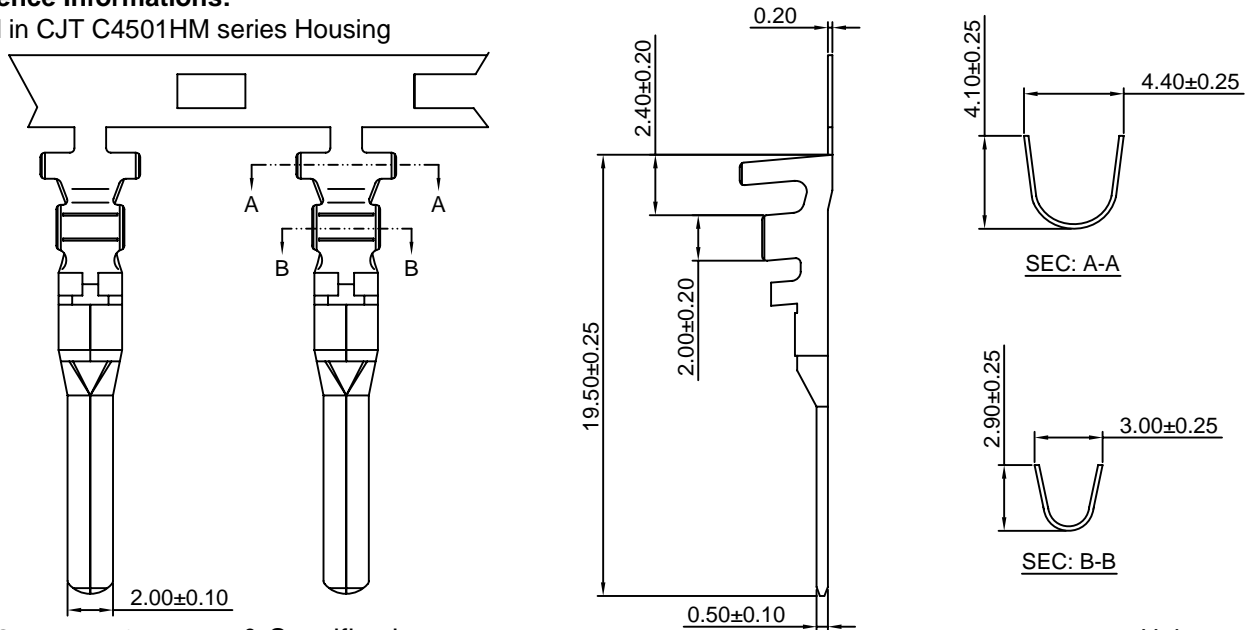

### Ordering information & Specifications:

Unit:mm

Part NO.	Wire Range	Insulation O.D.	Material	Finish	Qty/reel
C4501M-TP	AWG#16-#20	3.40mm(max)	Phosphor Bronze	Tin over Nickel	4,000 PCS
C4501M-GP	AWG#16-#20	3.40mm(max)	Phosphor Bronze	Gold over Nickel	4,000 PCS
C4501M-TP-L	AWG#20-#26	2.50mm(max)	Phosphor Bronze	Tin over Nickel	4,000 PCS
C4501M-GP-L	AWG#20-#26	2.50mm(max)	Phosphor Bronze	Gold over Nickel	4,000 PCS

Optional Gold plating available but MOQ requested

## C4501H

4.50mm Pitch Housing

### Reference Informations:

- \*Material: Nylon 66, UL94V-0
- \*Retainer Material: Nylon 66, UL94V-0
- \*Suitable CJT C4501 series Terminal
- \*Color: White
- \*Retainer Color: Ivory

Unit: mm

C4501HF	C4501HM<HMA>	Retainer
<p><u>C4501HF-1P</u></p>	<p><u>C4501HM-1P</u></p>	<p><u>C4501S-1P</u></p>
<p><u>C4501HF-2P</u></p>	<p><u>C4501HM-2P</u></p>	<p><u>C4501S-2P</u></p> <p>(commonly used for 2 circuit housing and 2x2 circuit housing)</p>
	<p><u>C4501HMA-2P</u></p>	
<p><u>C4501HF-3P</u></p>	<p><u>C4501HM-3P</u></p>	<p><u>C4501S-3P</u></p> <p>(commonly used for 3 circuit housing and 2x3 circuit housing)</p>
	<p><u>C4501HMA-3P</u></p>	

## C4501H

4.50mm Pitch Housing

Unit: mm

C4501HF	C4501HM	Retainer
<p><u>C4501HF-2x2P</u></p>	<p><u>C4501HM-2x2P</u></p> <p><u>C4501HMA-2x2P</u></p>	<p><u>C4501S-2P</u></p>
<p><u>C4501HF-2x3P</u></p>	<p><u>C4501HM-2x3P</u></p> <p><u>C4501HMA-2x3P</u></p>	<p><u>C4501S-3P</u></p>

## C4501H

4.50mm Pitch Housing

Unit: mm

C4501HF	C4501HM	Retainer
<p><u>C4501HF-2x4P</u></p>	<p><u>C4501HM-2x4P</u></p> <p><u>C4501HMA-2x4P</u></p>	<p><u>C4501S-4P</u></p>
<p><u>C4501HF-2x6P</u></p>	<p><u>C4501HM-2x6P</u></p>	<p><u>C4501S-6P</u></p>
<p><u>C4501HF-2x8P</u></p>	<p><u>C4501HM-2x8P</u></p>	<p><u>C4501S-8P</u></p>

## C4501H

4.50mm Pitch Housing

Unit: mm

C4501HF	C4501HM	Retainer
<p><u>C4501HF-3x3P</u></p>	<p><u>C4501HM-3x3P</u></p>	
<p><u>C4501HF-3x4P</u></p>	<p><u>C4501HM-3x4P</u></p>	
<p><u>C4501HF-3x5P</u></p>	<p><u>C4501HM-3x5P</u></p>	